

Data Sheet



Article number: 20379332

Description: E+G Handwheel
GN 323-200-K18-R

Measures

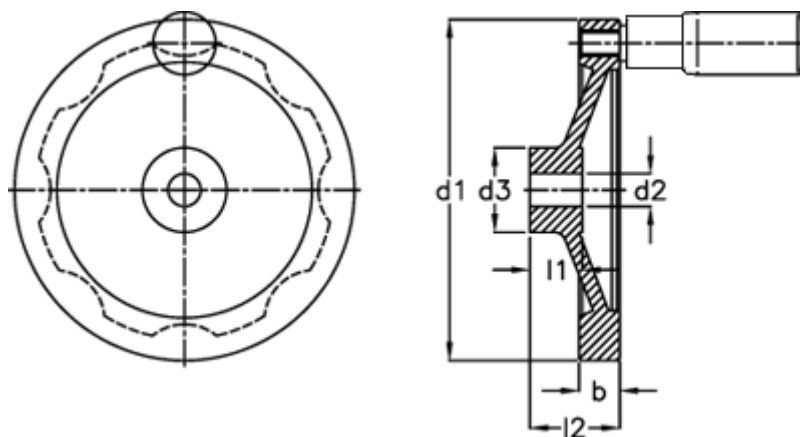

b = 20.5

d1 = 200

d2 H7 = 18

d3 = 45

Handle = 25

l1 = 24

l2 = 45